

The First Age

The Houses of the Edain (1) The First and Second Lines of the House of Bëor

310 Bëorians arrive in Ossiriand
311 Bëor enters Finrod's service

Continuous migration to Dorthonion till 360

365 Bereg leaves Beleriand

455 The Fell Year
457 Tol Sirion conquered
Easterlings arrive in Beleriand

460 Outlaws perish in Dorthonion

467 Silmaril stolen from Morgoth

472 The Year of Lamentation

503 First sack of Menegroth

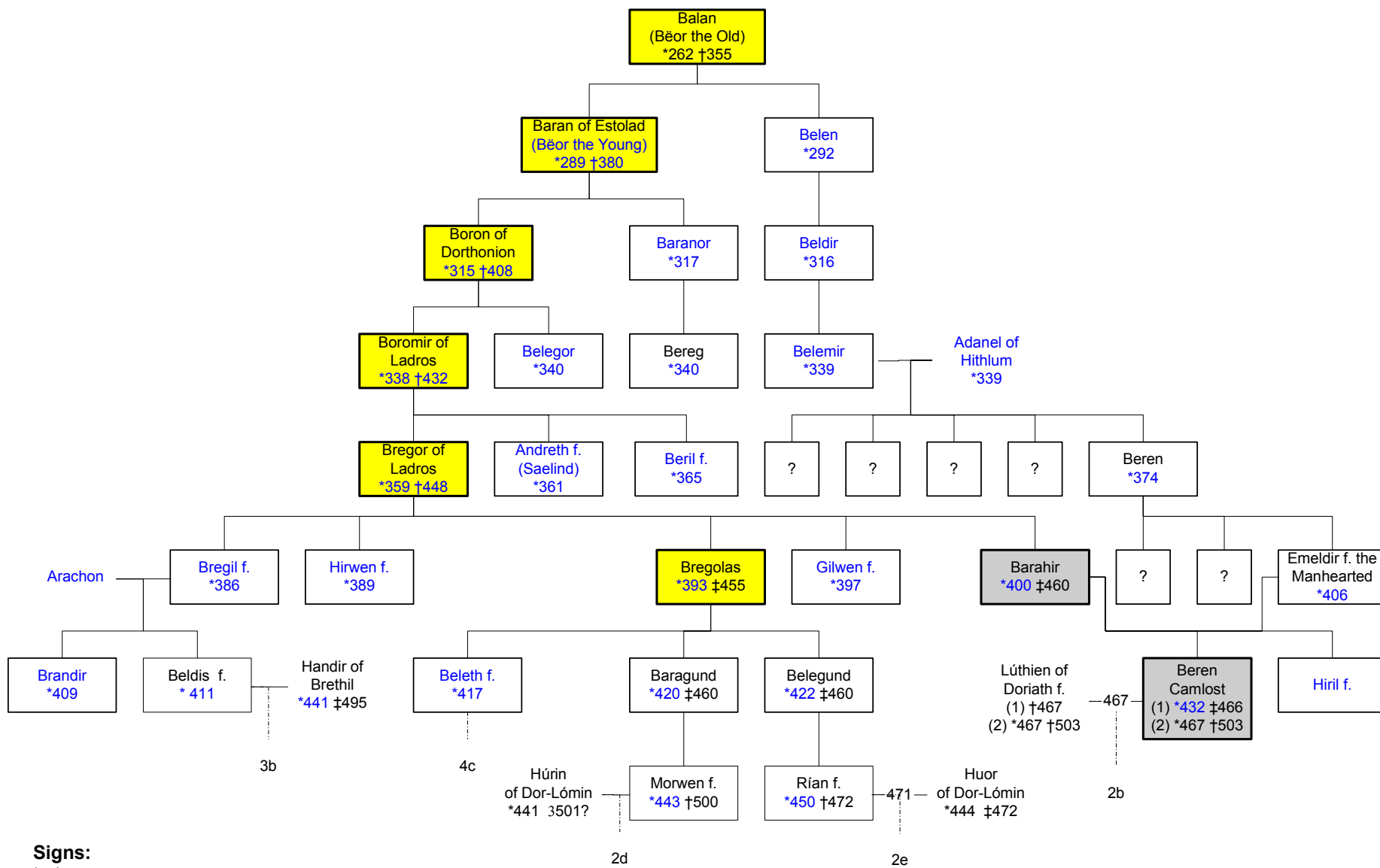

Signs:

- * born
- † died by natural cause
- ‡ died by unnatural cause
- v last reported alive
- ascended
- left or lost the throne

The Houses of the Edain

(2a) The People of Marach (afterwards the House of Hador)

(2b) The Half-Elves

all dates, unless otherwise stated, are First Age

313 (314m) People of Marach enter Beleriand

322-336 Malach in Hithlum

Magor moves to Ered Wethrin
365 Amlach in Maedhros' service

ca. 425 Fingolfin grants Dor-Lómin to Hador

455 The Fell Year

462 Angband attacks Hithlum
Eithel Sirion defeated

472 The Year of Lamentation
Easterlings under Lorgan occupy Hithlum

495 Sack of Nargothrond
499 Death of Glaurung
506 Second Kin-slaying
510 Fall of Gondolin

530 Túor sails West

540 Eärendil sails West
The War of Wrath begins

Drowning of Beleriand

590 End of the First Age

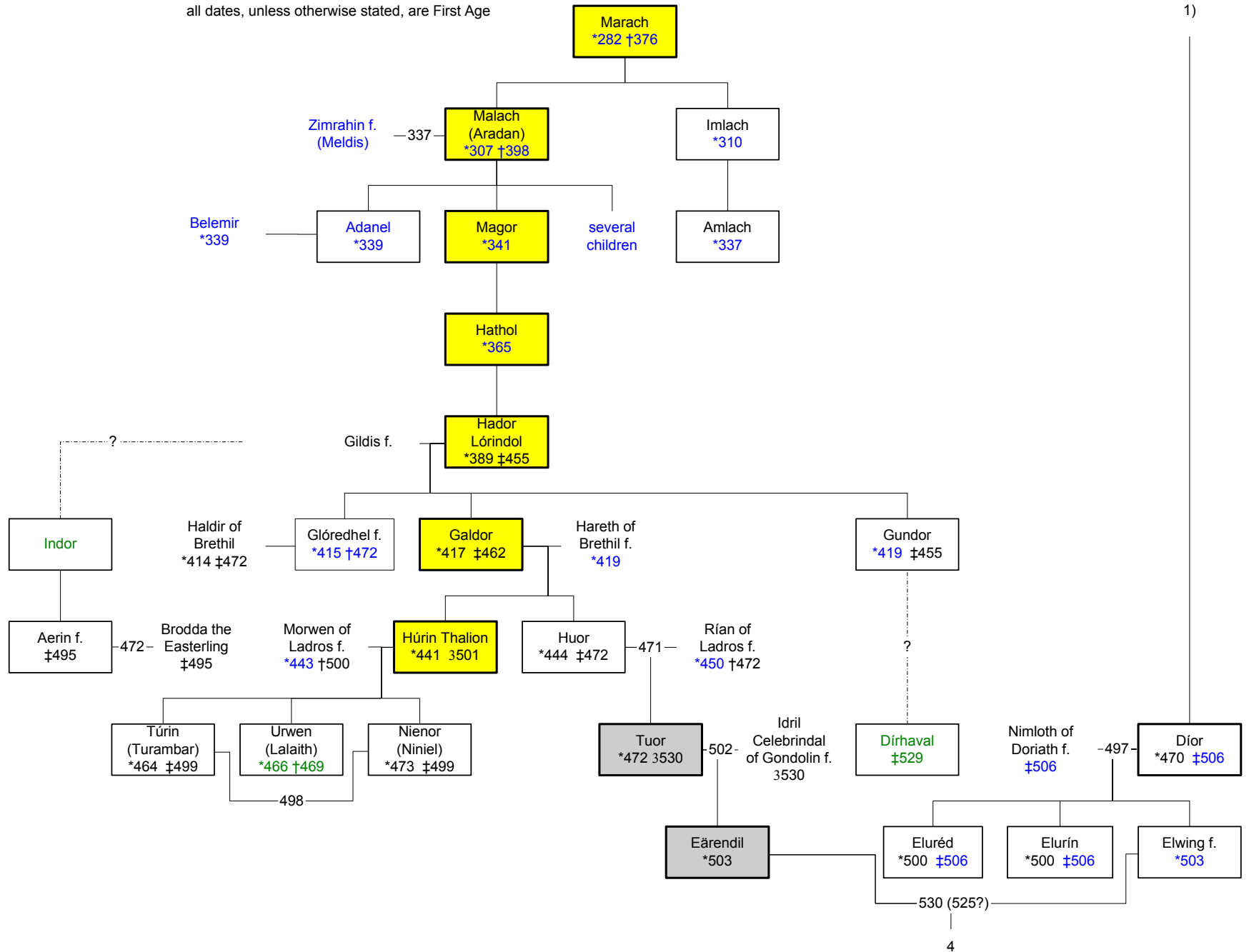

1)

The Houses of the Edain (3) The Haladin or People of Haleth

312 or 313 Haladin enter Ossiriand

375 Orc-raid in Thargelion

Haleth leads Haladin to Brethil

455 The Fell Year
Brethil defended

472 The Year of Lamentation

495 Battle of Tumhalad

500 End of the House of Haleth
"Lesser men" begin to rule Brethil

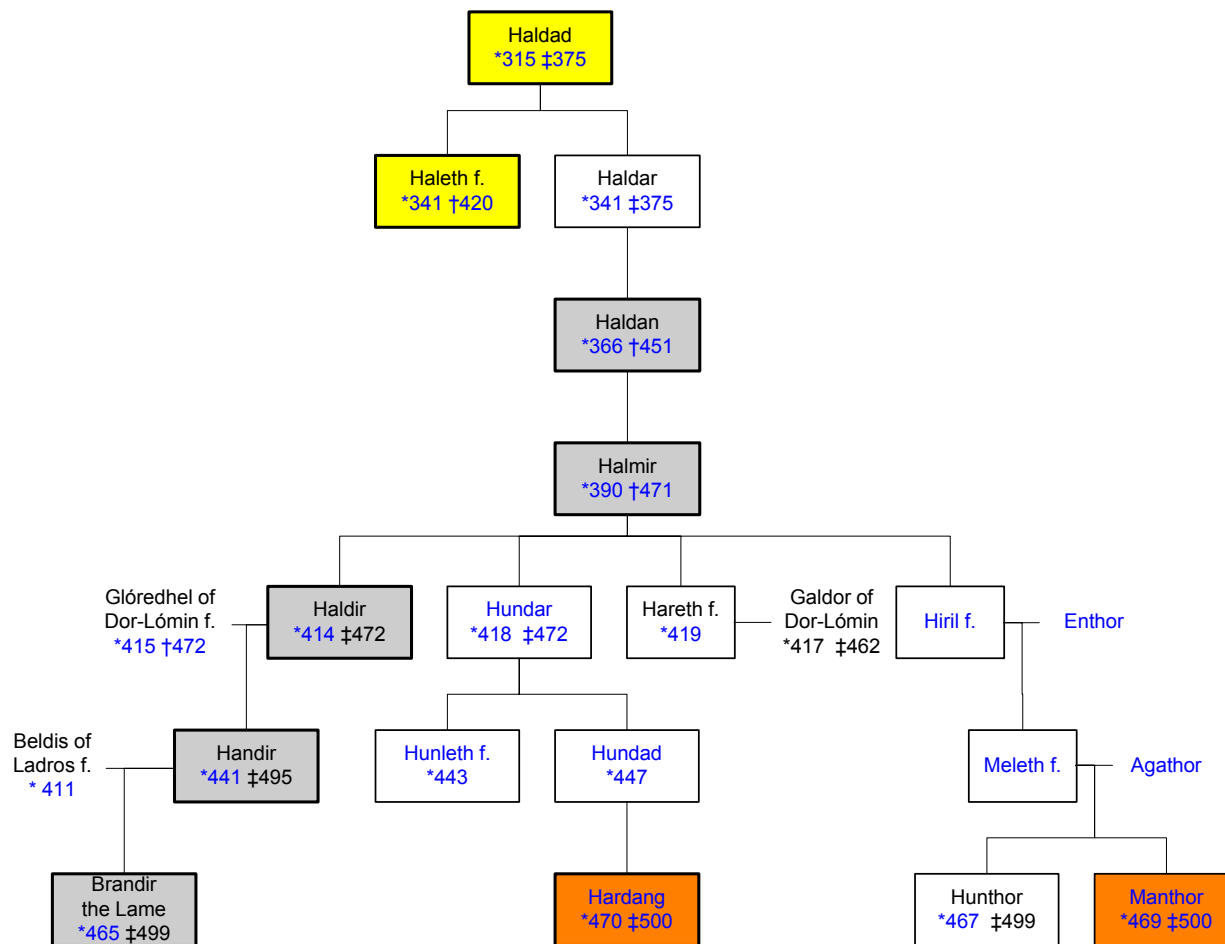

The Second Age

The Line of Elros - The Age of Glory (4): The first line and the early Lords of Andunië

Lines that had male heirs in 892 SA

32 Edain reach Númenor

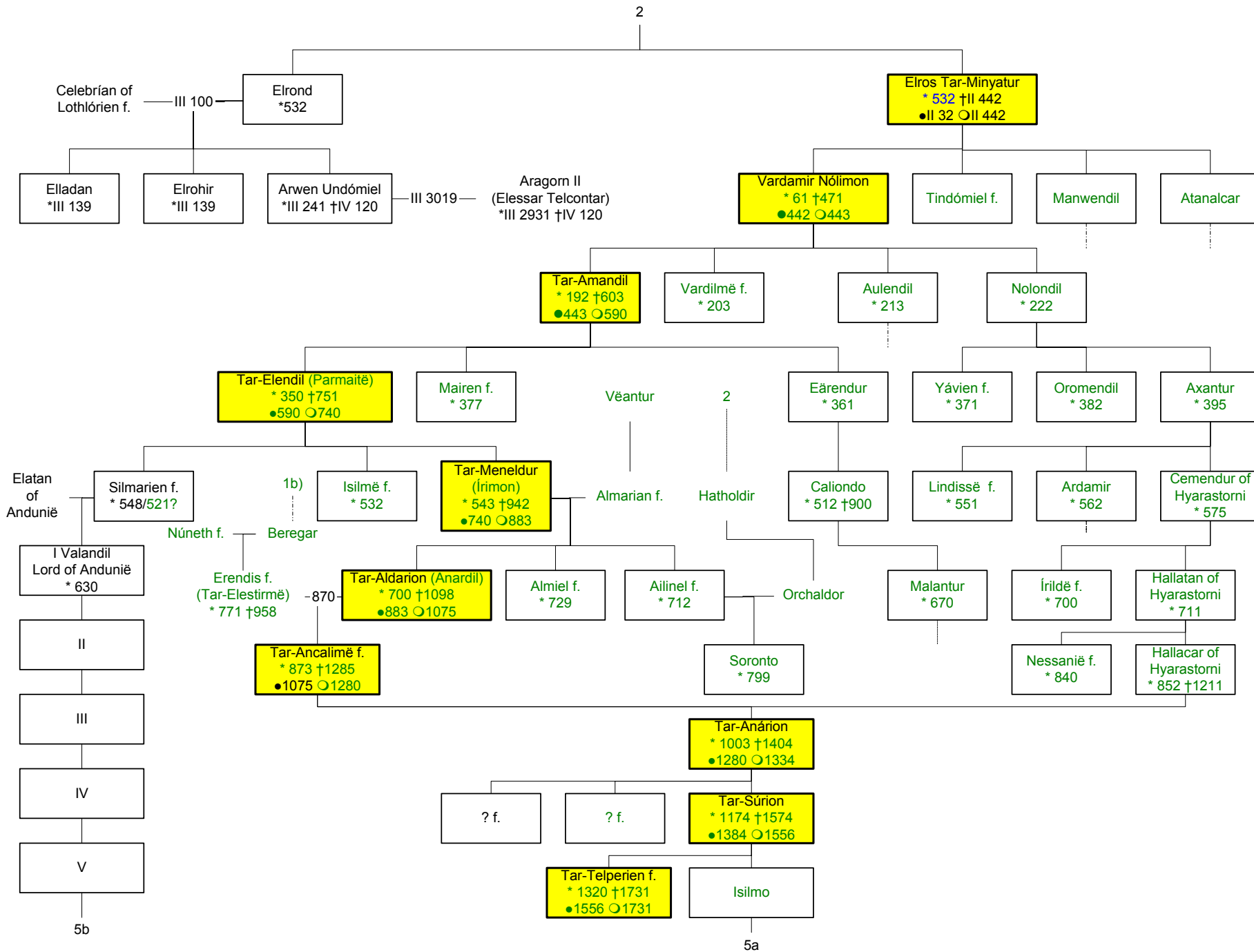

600 Vëantur returns to Middle-earth

750 Guild of Venturers founded

892 Change of succession law

Foundation of Vinyalondë

1000 Sauron enters Mordor

1200 Many Númenorean havens founded in Middle-earth

Elatan of Andunië

I Valandil Lord of Andunië * 630

II

III

IV

V

5b

5a

The Line of Elros - The Age of Shadow

(5a) The second line

(5b): The Lords of Andunie

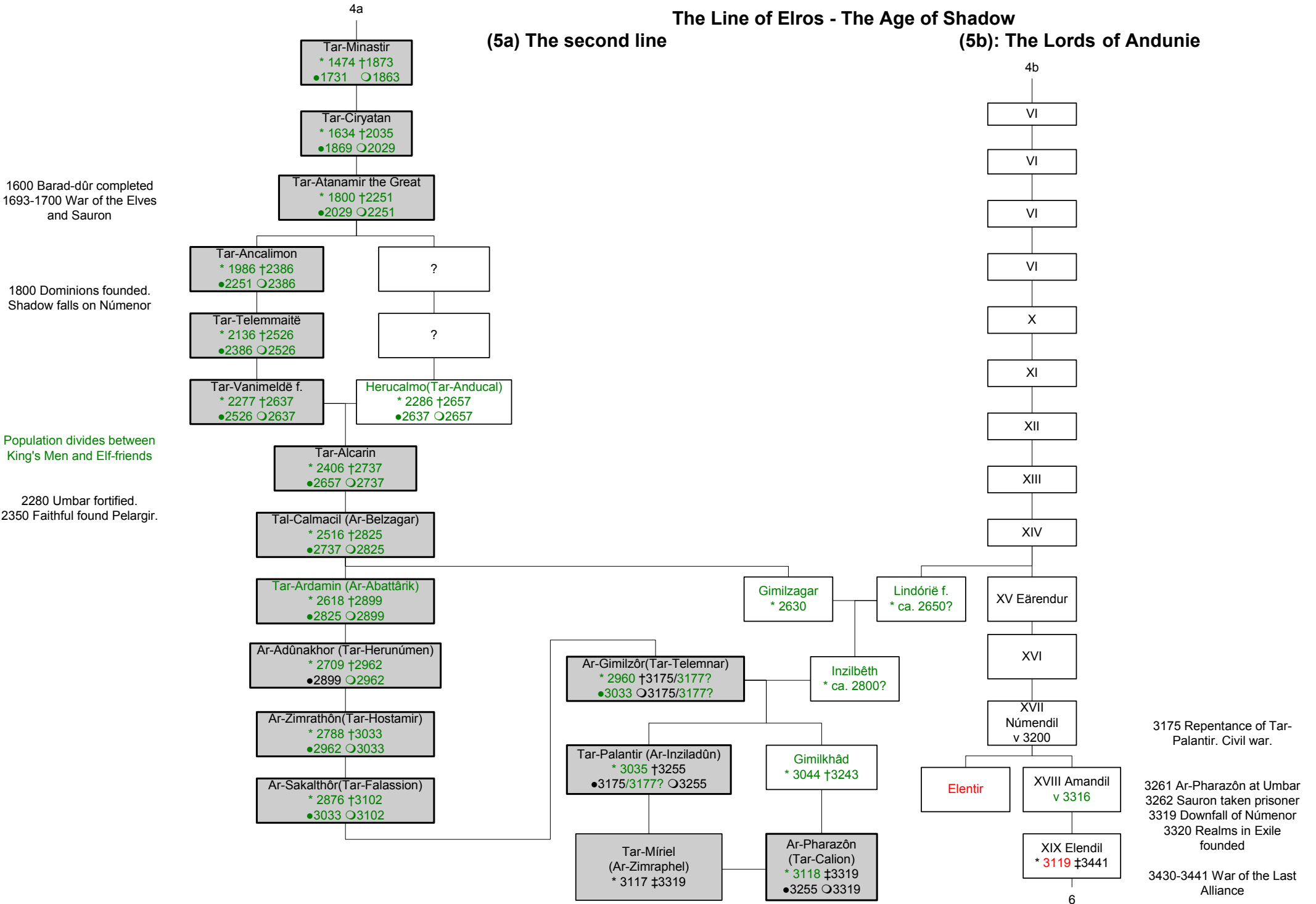

The Third Age

The Heirs of Elendil - foundation of the Realms in Exile (6a): The kings of Arnor (6b): The first line of the Kings of Gondor

all dates, unless otherwise stated, are
Third Age

5 b

2 Disaster of the Gladden
Fields

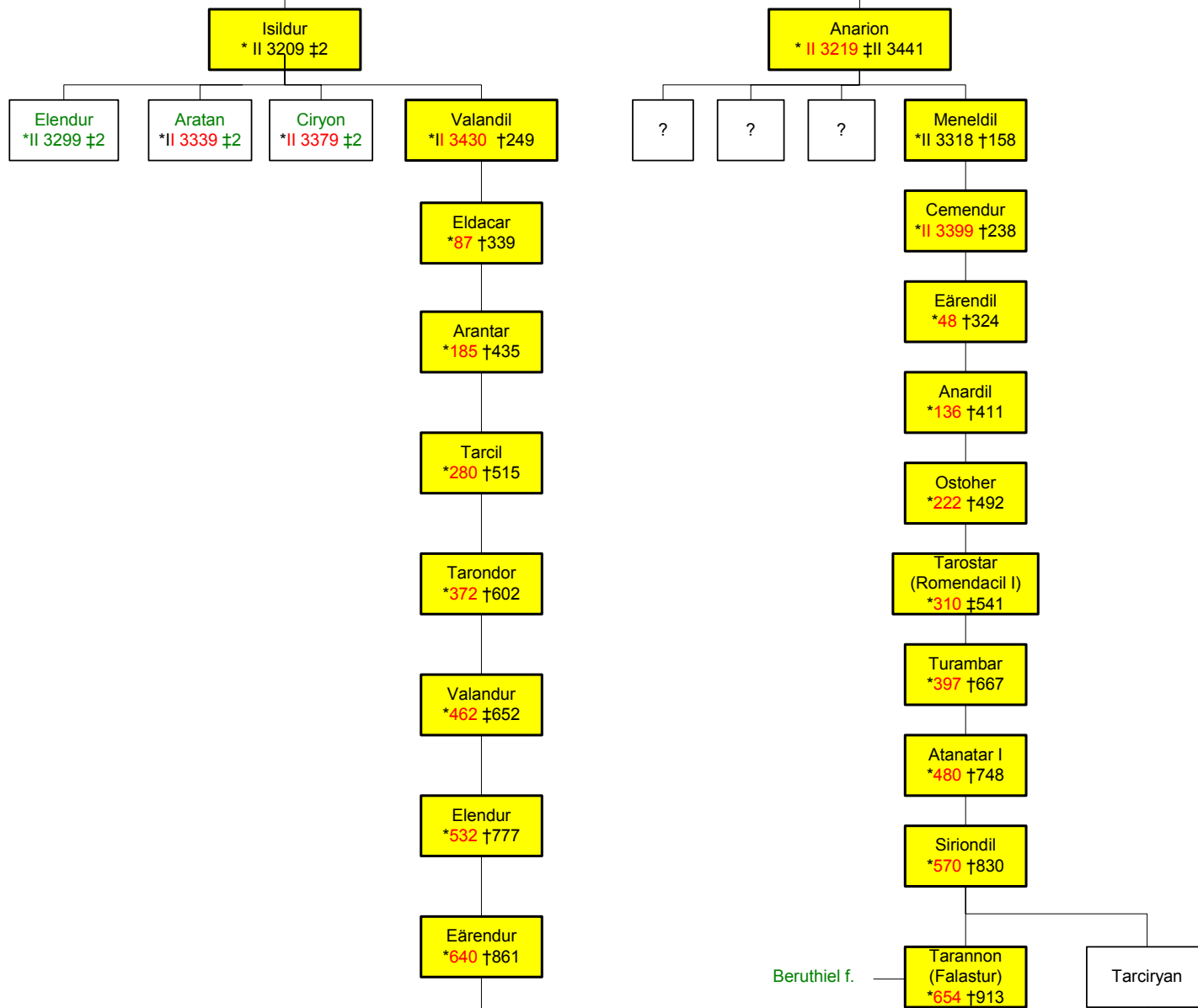

420 Minas Anor rebuilt

490-500 Invasion of
Easterlings

Stewardship of Gondor

ca. 900 Pelargir rebuilt

7a

7b

The Heirs of Elendil - The crisis of the kingship

(7a): The kings of Arthedain (7b): The second and third line of the Kings of Gondor

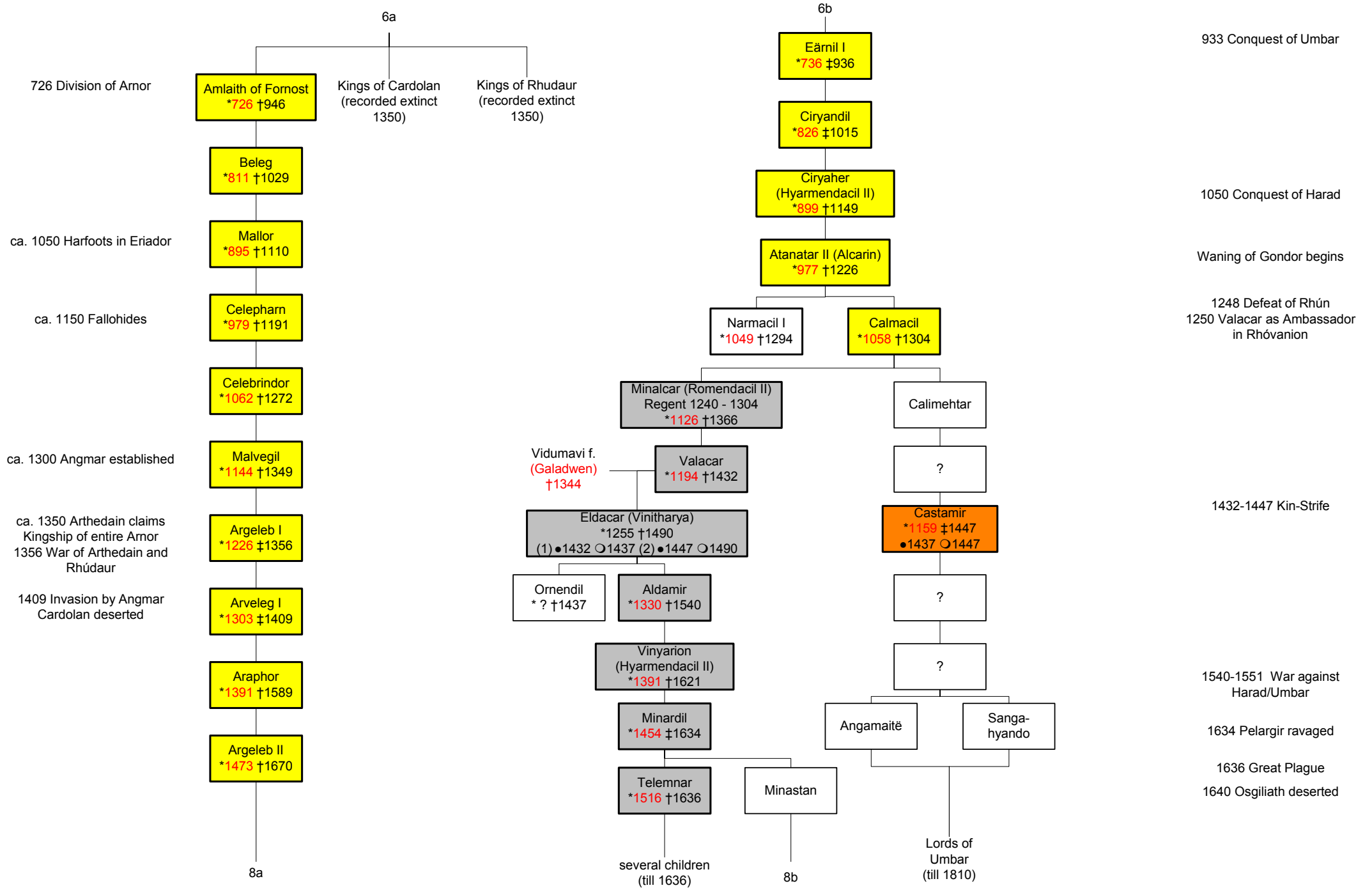

The Heirs of Elendil - The failure of the royal houses

(8a): The last kings of Arthedain (8b): The fourth and fifth line of the Kings of Gondor

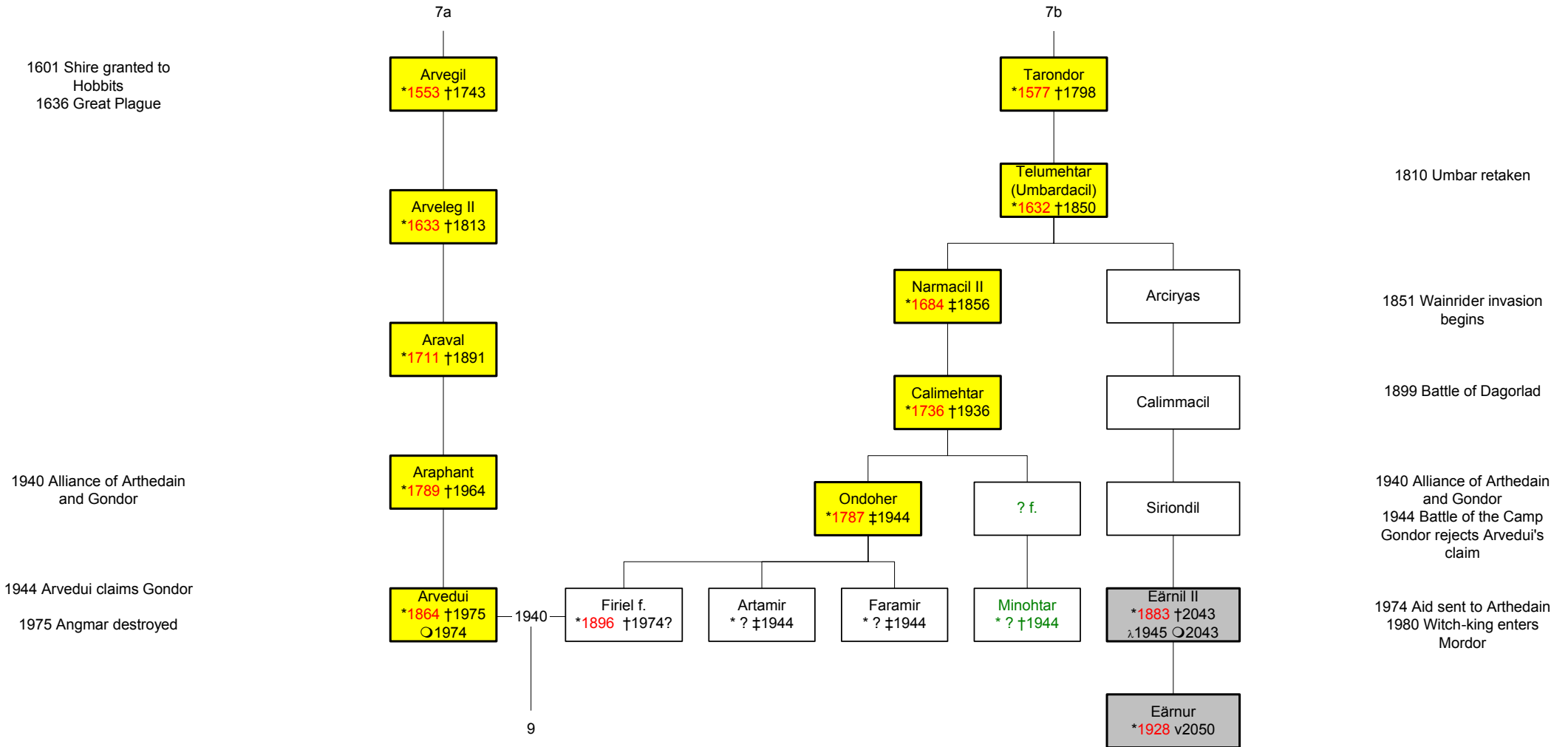

The Heirs of Elendil - Restoration of the Kingship (9) Chieftains of the Rangers and Kings of the Reunited Kingdom

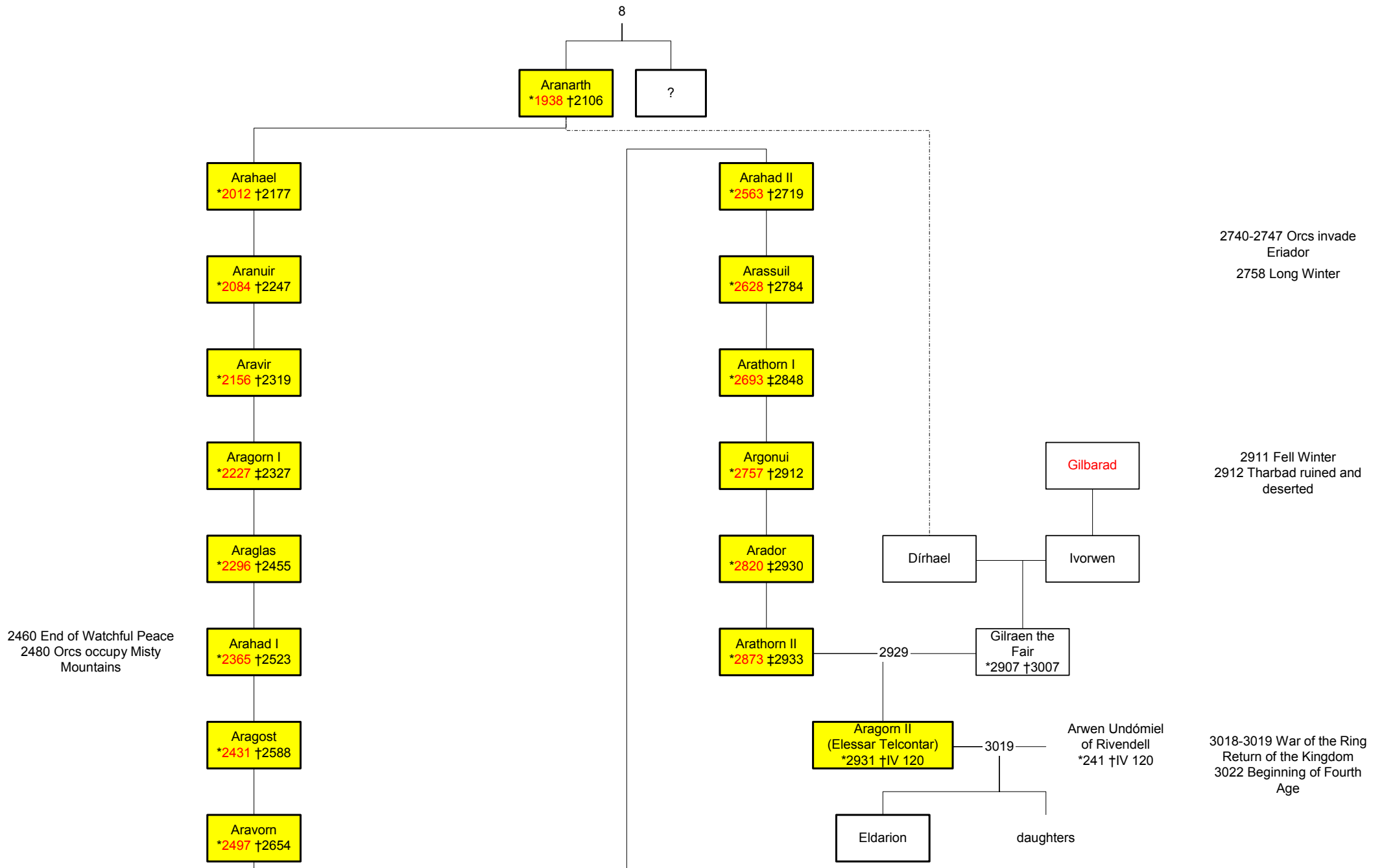

The House of Emyrn Arnen - The Watchful Peace (10) The first and second lines of the Ruling Stewards

The Line of Elros

ca. 1620 Steward chosen from Emyrn Arnen

1980 Witch-king returns to Mordor

2000-2002 Minas Ithil besieged and conquered by Mordor

2050 End of the Line of Anárion
Begin of the Rule of the Stewards

2063-2460 Watchful Peace

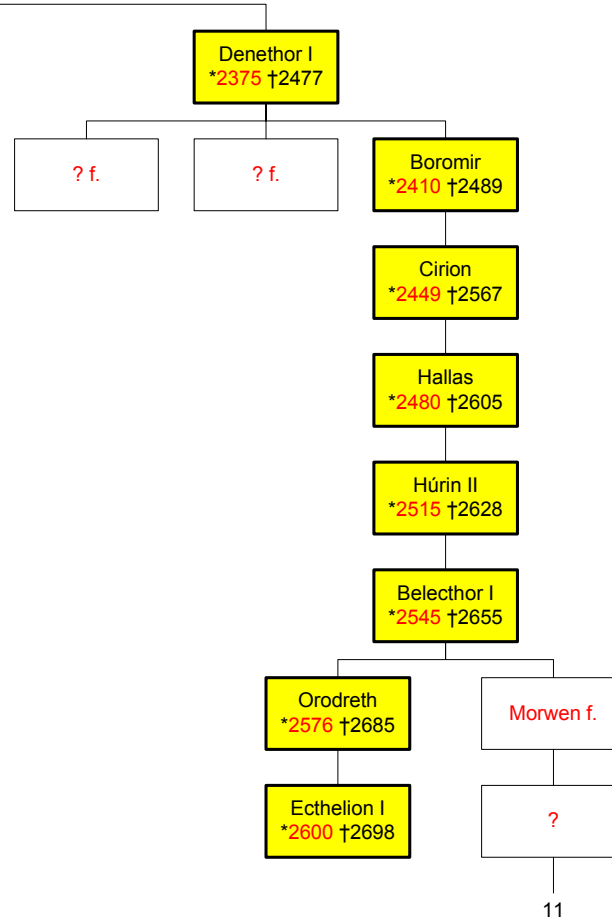
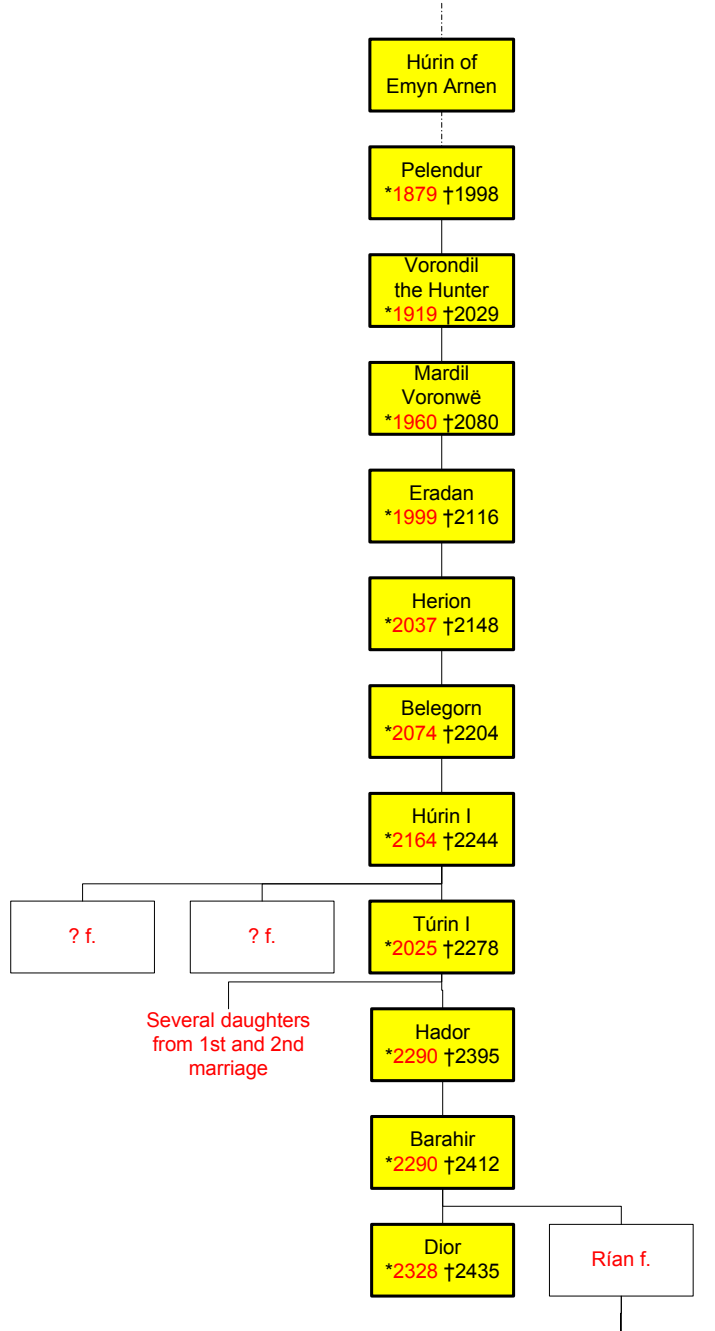

2475 Osgiliath finally ruined

2510 Balchoth wars;
Oath of Eorl

2698 White Tower built in Minas Tirith

The House of Eryn Arnem - Decline and Restoration

(11a) The third line of the Ruling Stewards
(11b) The Princes of Ithilien

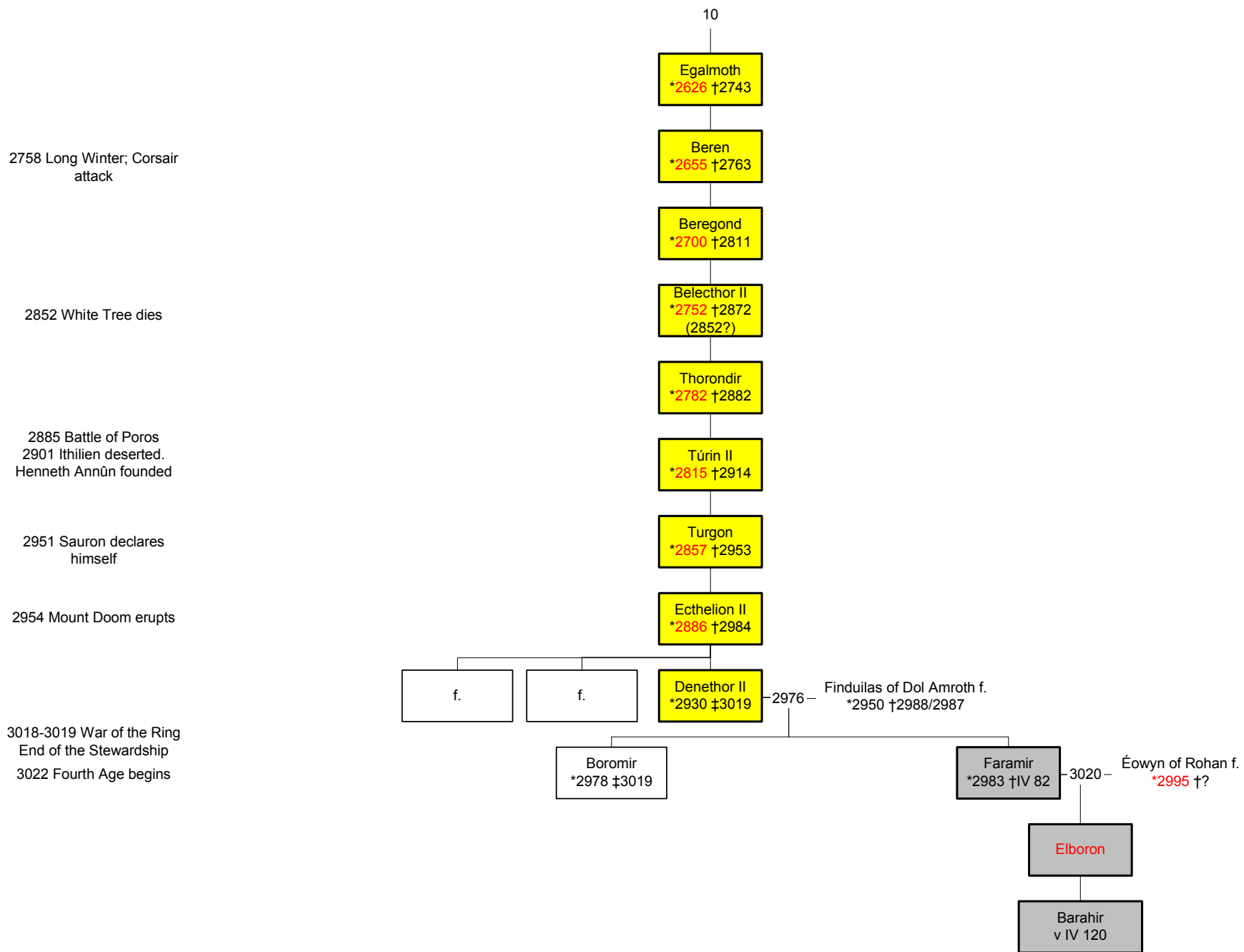

2758 Long Winter; Corsair attack

2852 White Tree dies

2885 Battle of Poros
2901 Ithilien deserted.
Henneth Annûn founded

2951 Sauron declares himself

2954 Mount Doom erupts

3018-3019 War of the Ring
End of the Stewardship
3022 Fourth Age begins

The Princes of Dol Amroth

(12a) Early Princes

(12b) Late Princes

1980 Witch-king returns to Mordor

2000-2002 Minas Ithil besieged and conquered by Mordor

2050 End of the Line of Anárion

2475 Osgiliath finally ruined

2510 Balchoth wars; Oath of Éorl

Adrahil of Dol Amroth
v 1944

Imrazôr the Númenórean
*1950 †2076

Mithrellas of Lothlórien f.

Gilmith f.

Galador
*2004 †2129

II
*2060 †2203

III
*2120 †2254

IV
*2172 †2299

V
*2225 †2348

VI
*2274 †2400

VII
*2324 †2458

VIII
*2373 †2498

IX
*2418 †2540

X
*2463 †2582

XI
*2505 †2623

XII
*2546 †2660

XIII
*2588 †2701

XIV
*2627 †2733

XV
*2671 †2746

XVI
*2709 †2799

XVII
*2746 †2859

XVIII
*2785 †2899

Aglahad
*2827 †2932

Angelimir
*2866 †2977

Adrahil
*2917 †3010

Morwen f. (Steelsheen)
*2922 †?

Thengel of Rohan
*2905 †2980

Ivriniel f.
*2947 †?

Denethor II
*2930 †3019

-2976-

Finduilas f.
*2950 †2988/2987

Imrahil
*2955 †3054

Elphir
*2987 †IV 65

Erchirion
*2990 †?

Amrothos
*2994 †?

Lothíriel
*2999 †?

3019-

Éomer Éadig
*2991 †IV 63

Alphros
*3017 †IV 93

2698 White Tower built in Minas Tirith

2758 Long Winter; Corsair attack

2852 White Tree dies

2885 Battle of Poros
2901 Ithilien deserted.
Henneth Annûn founded

2951 Sauron declares himself

2954 Mount Doom erupts

3018-3019 War of the Ring

3022 Beginning of Fourth Age

?

?

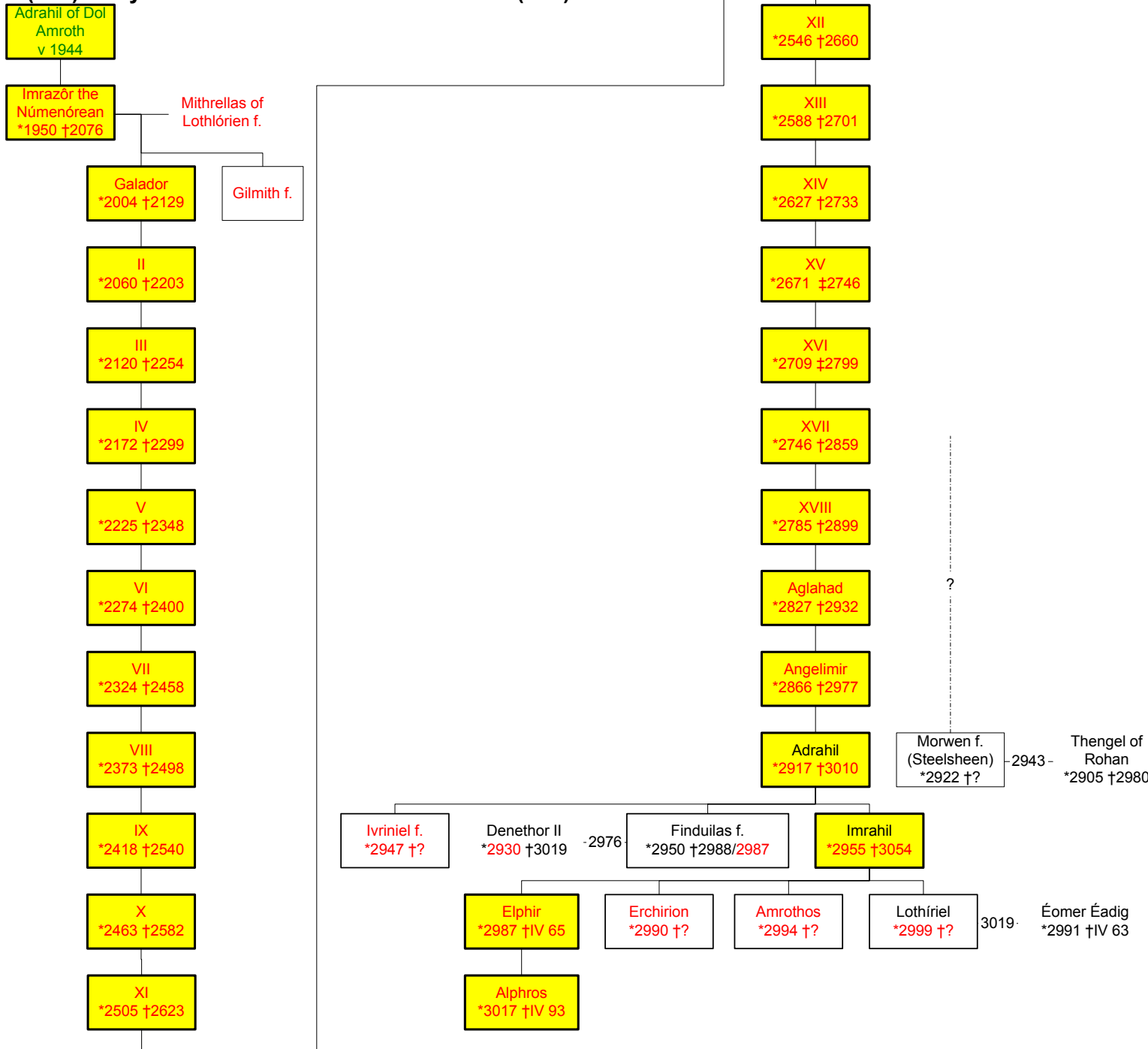

The Origin of the Kings of Rohan

(13a) Lords of the Éothéod

(13b) The first line of Rohan

1248 Gondor defeats Rhún

1250 Valacar as
Ambassador in Rhóvanion

1432-1447 Kin-Strife
1636 Great Plague

1851 Wainrider invasion
begins
1899 Battle of Dagorlad

before 1936: Éothéod first
time recorded

1944 Battle of the Camp.

1977 Frumgar leads Éothéod
north

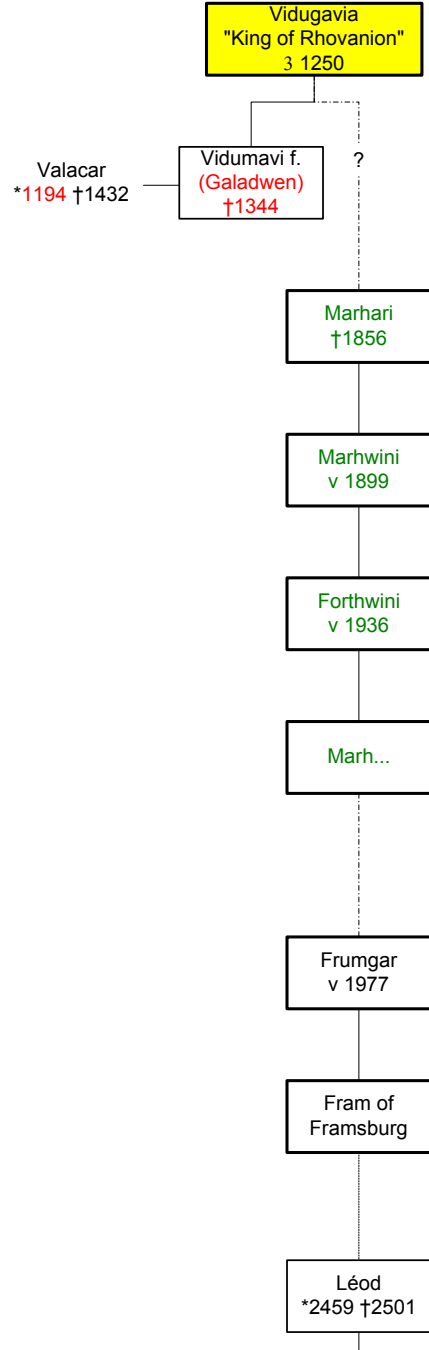

Valacar
*1194 †1432

?

Vidumavi f.
(Galadwen)
‡1344

Marhari
‡1856

Marhwini
v 1899

Forthwini
v 1936

Marh...

Frumgar
v 1977

Fram of
Framsburg

Léod
*2459 ‡2501

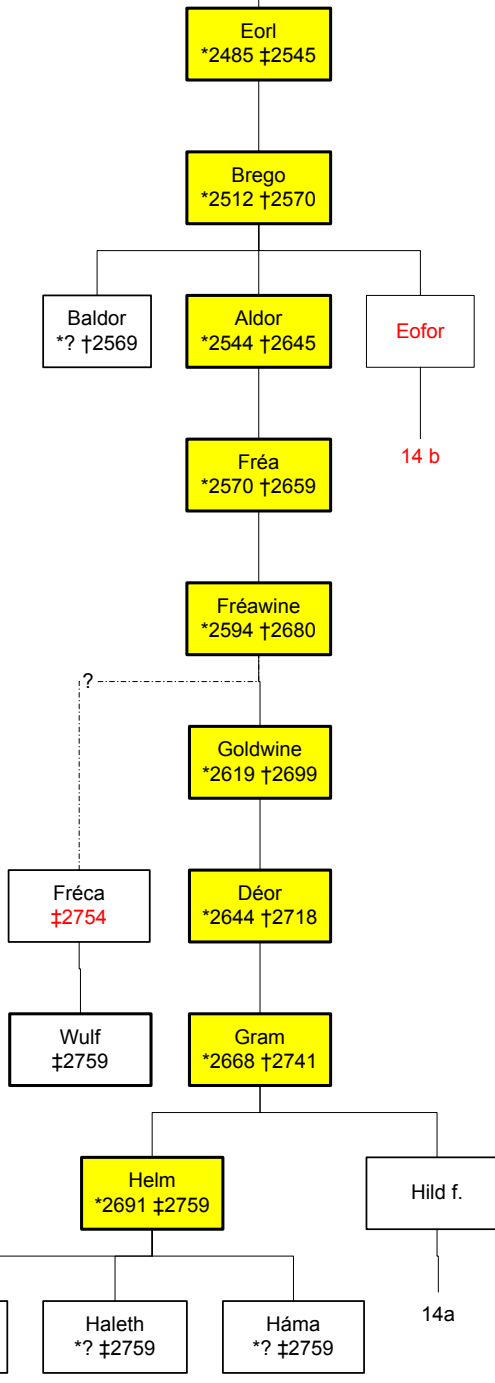

2510 Oath of Eorl
Aldburg founded
2545 Battle in the Wold

Edoras founded

Dunlendings routed

2710 Dunlendings occupy
Isengard

2758 Long Winter
Wulf usurps Edoras
2759 Wulf slain; Saruman in
Isengard

The Kings of Rohan

(14a) The second and third line
(14 b) the Lords of Aldburg

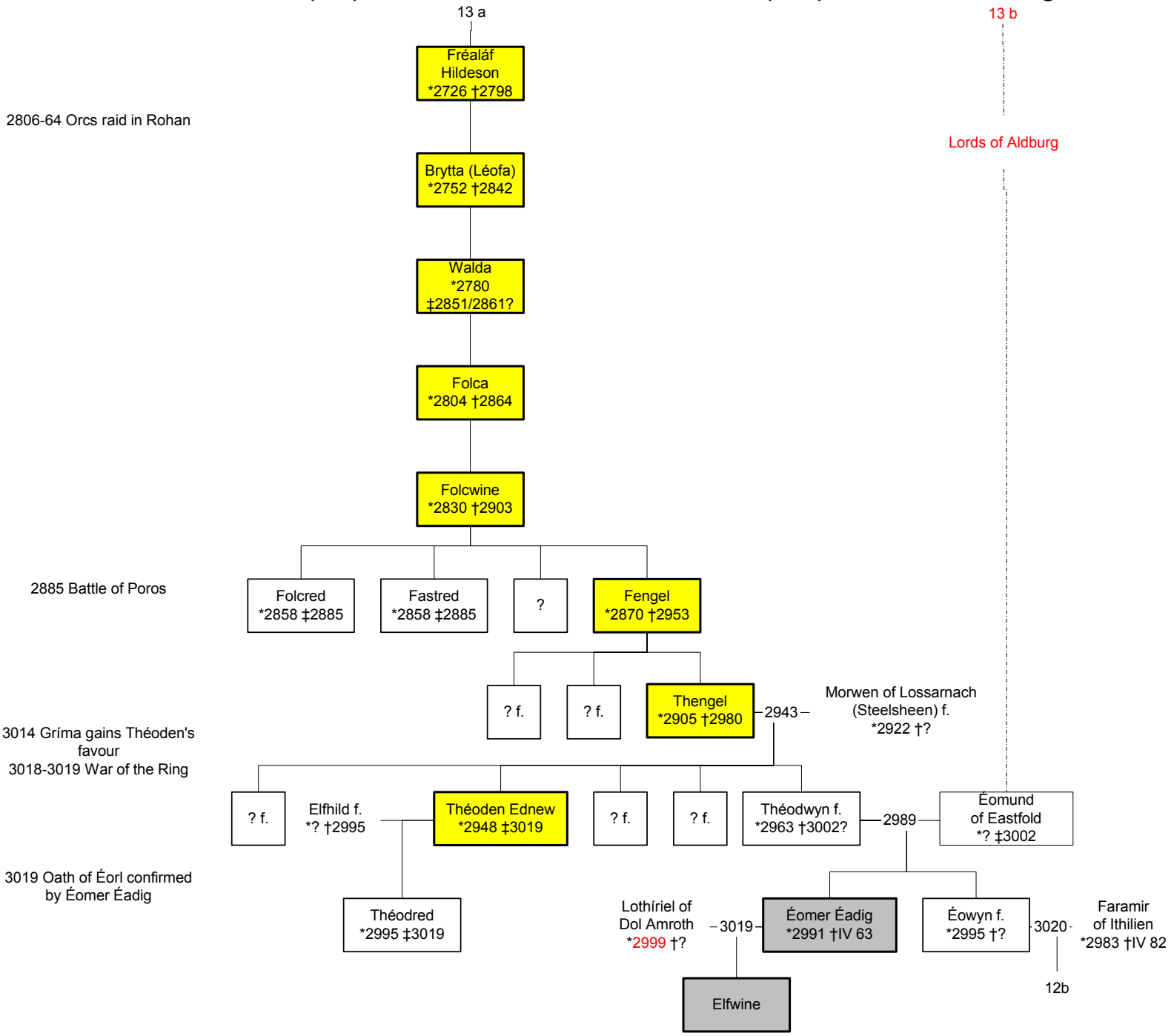

(15) The Lords and Kings of Dale

2590 Erebor founded
Dale built
Reign of King Bladorthin

2770 Smaug destroys Dale
End of Lordship of Dale

2941 Death of Smaug
Kingdom of Dale founded
2944 Rebuilding of Dale begun

Kingdom of Dale expands
along Celduin/Carmen

Dale expands South and
East
3018-3019 War of the Ring

